



# ATILIM HİDROLİK

MAKİNE VE EKİPMANLARI



HİDROLİK PnöMATİK

[www.atilimhidrolik.com.tr](http://www.atilimhidrolik.com.tr)



# HAKKIMIZDA

*Müşteri taleplerine en kısa sürede, en uygun ürün ile cevap veren ATILIM HİDROLİK, yaptığı müşteri ziyaretleri ile Türk Sanayisinin hizmetine sunduğu ürünlerin performansını değerlendirip, gelen talepler doğrultusunda teknolojik yenilikler sunmaktadır.*

*Tüm uygulamalarda kullanılacak hidrolik, pnömatik ürünlerini mümkün olabilen en kısa sürede müşteriye teslimini sağlayabilecek güçlü bir stoğa sahiptir.*

*HİDROLİK – PNOMATİK sektöründe dünya lideri markaların geniş ürün yelpazesine hizmet veren ATILIM HİDROLİK, müşteri talep ve ihtiyaçlarını eksiksiz karşılama ve teknik servis hizmetleriyle tercih edilmede ayrıcalıklı bir konuma gelmiştir.*

*Türk Sanayisine hizmet etmenin haklı gururunu yaşayan ATILIM HİDROLİK, hizmet kalitesinden ve prensiplerinden taviz vermeden, geçmişte olduğu gibi gelecekte de hizmetlerini sürdürecektir...*





# NELER SUNUYORUZ?

**HİDROLİK**

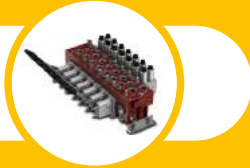

**PNOMATİK**

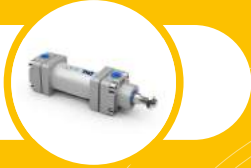

**MAKİNA EKİPMANLARI**



**İMALATLARIMIZ**



## ► HİDROLİK HORTUMLAR



► R1SN, R2SN, R2ST, R9 4SP, R9 4 SH  
R15, R5 SAE, R6

## ► HORTUM ÇEŞİTLERİ

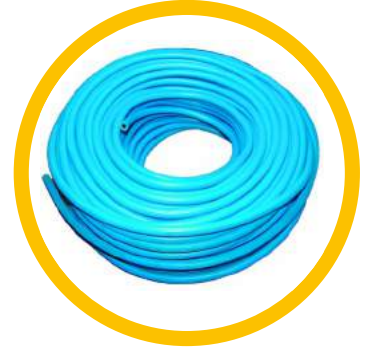

► Kompresör Hortumları, Hava Hortumları, Su Hortumları, Paslanmaz Hortumlar, Yüksek Basıncılı Hortumlar, Bezli Hortumlar, Gıda Hortumları, Akaryakıt Hortumları

## ► HORTUM PRES İŞLERİ

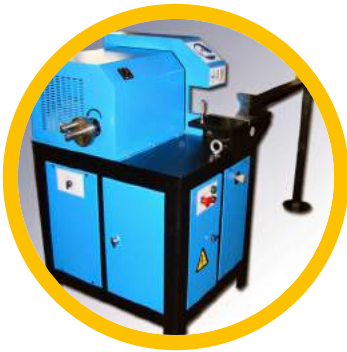

► Her Ebatta Hidrolik Hortum Ve Rakor Presi

## ► HİDROLİK KUMANDALAR

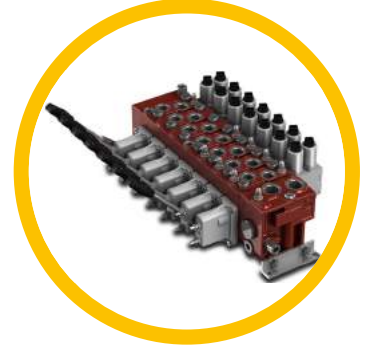

► Monoblok Kumandalar - Dilimli Kumandalar  
Oransal Elektro hidrolik Kumandalar

## ► HİDROLİK YÖN KONTROL VALFLERİ

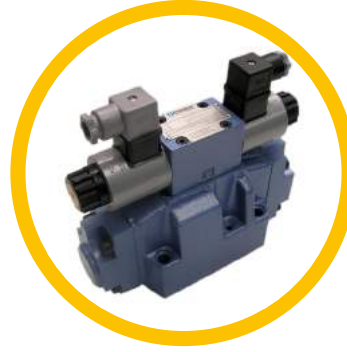

► Endüstriyel Valfler, Bobinli Valfler, Seçici Valfler  
Özel Valfler, Modüler Valfler

## ► HİDROLİK HAT TİPİ VALFLER

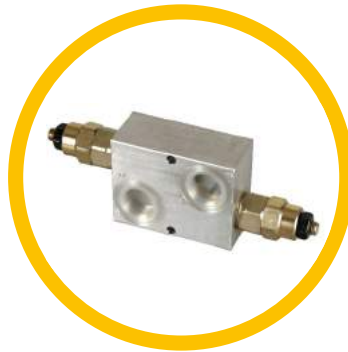

► Yük Tutma Valfleri, Basınç Sıralama Valfleri  
Basınç Emniyet Valfleri, İkiz Kilitlemeler  
Face Tipi Kilitler

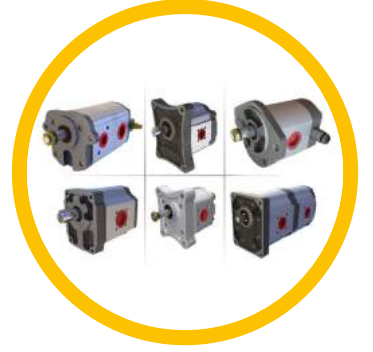
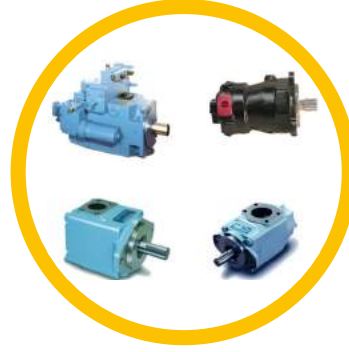
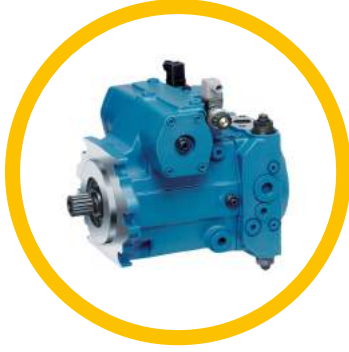

**► HİDROLİK POMPALAR**

- Döküm Gövde Dişli Pompalar, Pistonlu Pompalar, Tandem Pompalar, Alüminyum Gövde Pompalar, Değişken Debili Pompalar Radyal Pompalar

**► HİDROLİK MOTORLAR**

- Orbit Motorlar, Frenli Motorlar Radyal Pistonlu Motorlar

**► HİDROLİK YAĞ SOĞUTUCU**

- Elektrik Motorlu, Hidrolik Motorlu, Sulu Yağ Soğutucular

## ► HİDROLİK EL POMPASI



► Tek Tesirli Ve Çift Tesirli El pompaları

## ► HİDROLİK DEPO AKSESUARLARI



► Seviye Göstergeleri, Depo Kapakları  
Filtreler, Yağ Tankları

## ► HİDROLİK FİLTRELER



► Emiş Filtreleri, Dönüş Filtreleri, Basınç  
Filtreleri, Hat Tipi Emiş Dönüş Filtreleri



## ► HİDROLİK RAKORLAR



► Hidrolik Rakor Ve Hortum Başlıkları

## ► HİDROLİK KELEPÇELER

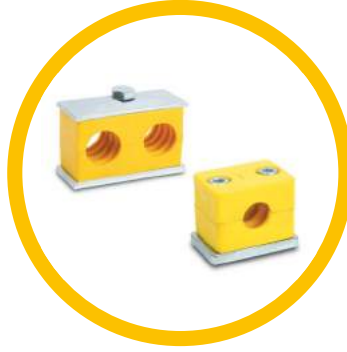

► Hidrolik Boru Kelepçeleri

## ► HİDROLİK VANALAR

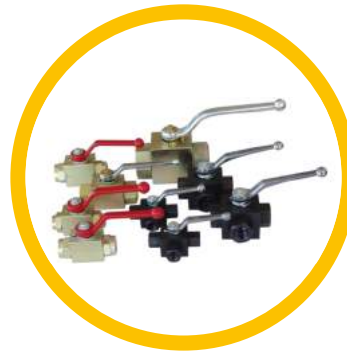

► Küresel Vanalar, Döküm Vanalar, Hız Ayar Valfleri, Flanş Bağlantılı Vanalar

## ► HİDROLİK GÜÇ ÜNİTESİ



► Tüm Ebat Ve Özelliklerde Uygulamalar Mevcuttur

## ► HİDROLİK KEP VE PİSTONLAR



► Döküm Boğaz Kepleri, Silindir Pistonlar  
Silindir Yivli Pistonlar, Yağ Girişli  
Arka Kapak, Silindir Arka Kapak

## ► HORTUM KABLO TAŞIMA KANALI

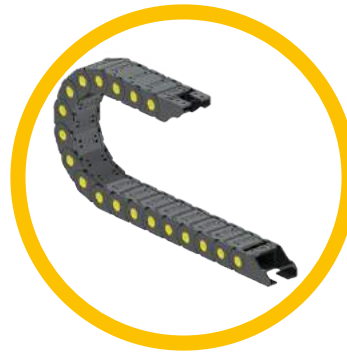

► Hareketli Kablo Taşıyıcılar Ve Yedek Parçaları

## ▶ PLANET REDÜKTÖRLER

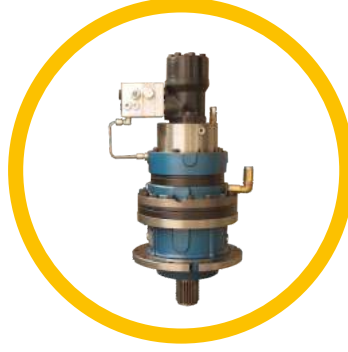

▶ Frenli Frensiz Redüktörler, Hidromotor Tahrikli Redüktörler, Tarım Redüktörleri

## ▶ PTO YAVRU ŞANZUMAN

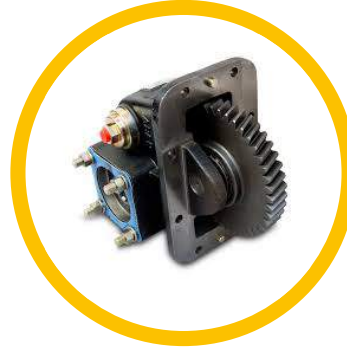

▶ Pto, Ara Şanzımanlar

## ▶ DC MOTORLAR



▶ Dc Motorlar Ve Mini Güç Ünitesi Motorları



## ► HİDROLİK BORULAR

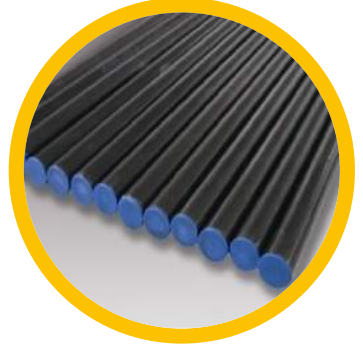
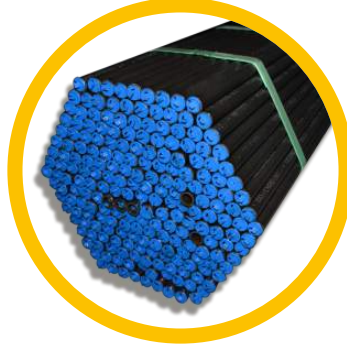
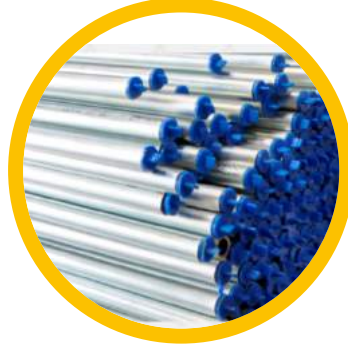
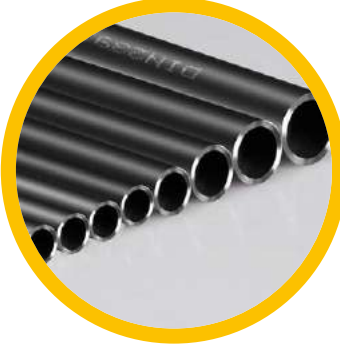

► Hidrolik Devre Boruları

## ► HİDROLİK SİLİNDİR



► Özel Amaçlı Silindirler, İş Ve İnşaat Makina Silindirleri, Tarım Makina Silindirleri ,yedek Parçalar

## ► HONLANMIŞ BORU KROMAJLI MİLLER

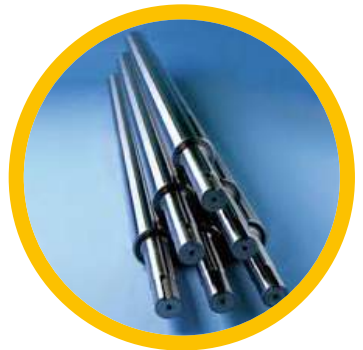
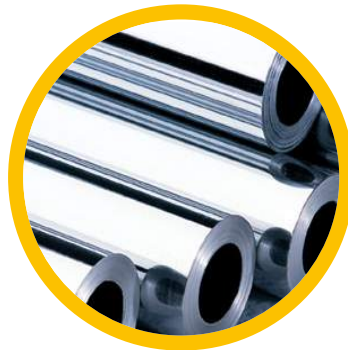

► H8, H9, Kromkaplı Milller, İndüksiyonlu Milller, Rod Borular

**► HİDROLİK BAĞLANTILARI****► Adaptörler ,Rakorlar ,Quick Kaplinler****► KAMPANA VE DİK FLANŞLAR-ESNEK KAPLINLER****► Motor Ve Pompa Kampanaları****► SIZDIRMAZLIK EKİPMANLARI****► Hidrolik Ve Pnomatik Sızdırmazlık Elemanları**

## ▶ MANOMETRE BASINÇ SAATLERİ



▶ Gliserinli Manometreler, Kuru Tip Manometreler  
Hassas Manometreler

## ▶ HİDROLİK ROTATOR BEYİNLER

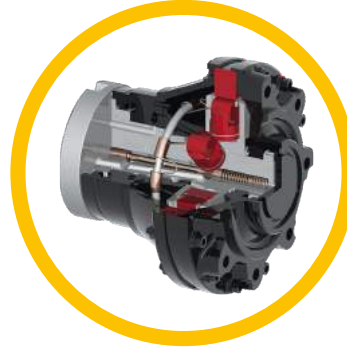

▶ Direksiyon Beyinleri, Actuatorler

## ▶ HİDROLİK PLEYTLER

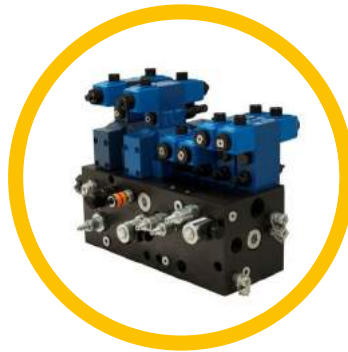

▶ Tekli, Modüler, Bypasslı



**► HİDROLİK KRİKO**

- Tek Tesirli Hidrolik Silindir Krikolar  
Çift Tesirli Hidrolik Silindir Krikolar

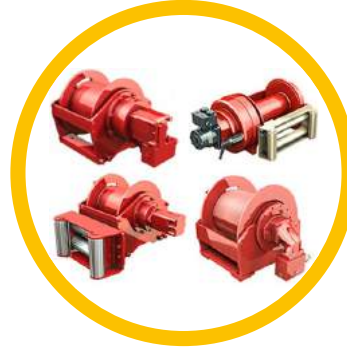
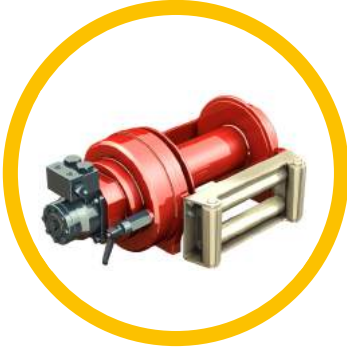
**► HİDROLİK HALAT TAMBURU**

- Çekme Tamburlar, Elektrikli Tamburlar  
Kaldırma Halat Tamburları

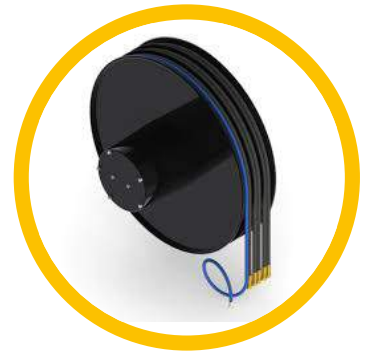
**► HORTUM VE KABLO TAMBURU**

- Kablo Tamburları, Elektrik Kablo Tamburları  
Hidrolik Hortum Tamburları

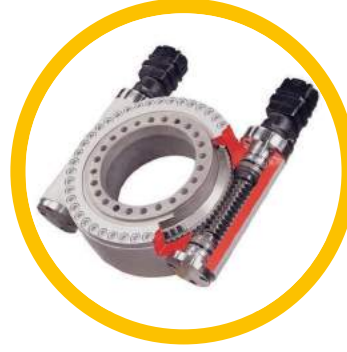
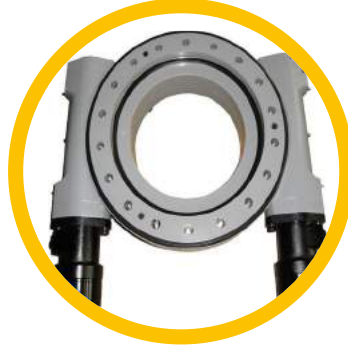
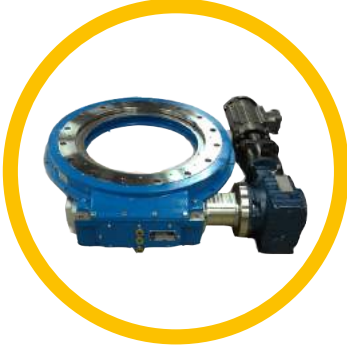
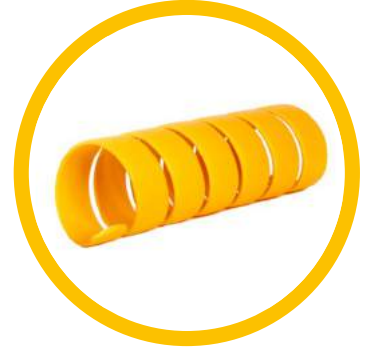
**▶ ROTARY DİŞLİLER****▶ Tek Sıra, Çift Sıra, Motor Tahrikli, Çember Dişliler****▶ HİDROLİK AKSESUARLAR****▶ Hortum Ve Kablo Koruyucular ,Termostatlar****▶ Joystickler, Denge Terazileri**

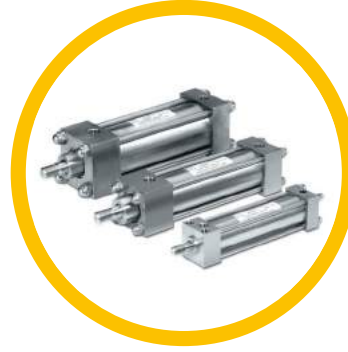
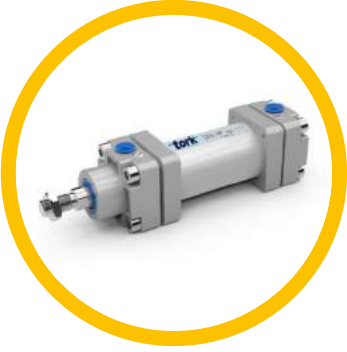
**► PNOMATİK RAKORLAR****► Pnomatik Rakor Çeşitleri****► PNOMATİK SİLİNDİRLER****► Tek Etkili, Çift Etkili, Özel Yapım Silindirler****► PNOMATİK VALFLER****► Elektrik Uyarılı, Hava Uyarılı, Kollu Mekanik, Modüler Valfler**



## ▶ PNOMATİK HORTUMLAR



▶ Poliamid Hortumlar, Poliüretan Hortumlar  
Teflon Hortumlar, Spiral Hortumlar

## ▶ PNOMATİK BAĞLANTILAR



▶ Eklem Bağlantıları, Yer Bağlantıları Ayak  
Bağlantıları, Flanş Bağlantıları, Çatal Bağlantı

## ▶ PNOMATİK MALZEMELER



▶ Pnomatik Aksesuar Çeşitleri

**► SWITCH VE SENSÖRLER**

► Endüktif Sensörler, Mekanik Switchler  
Limit Switchleri, Proximity Sensörler

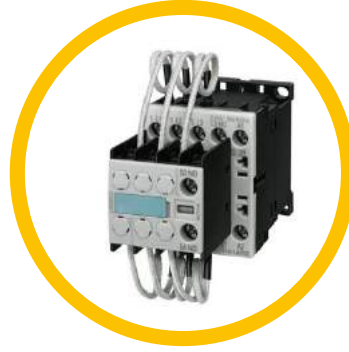
**► BUTONLAR RÖLELER KONTAKTÖRLER**

► Kumanda Butonları, Pako Şalter, Sinyal  
Lambası, Güvenlik Anahtarları, Röleler

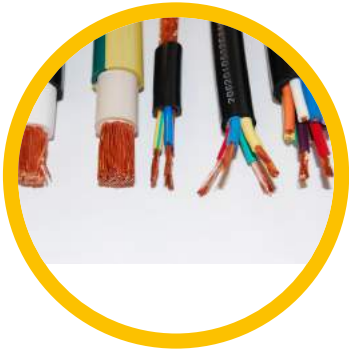
**► ELEKTRİK MALZEMELERİ KABLOLAR  
MOTORLAR PRİZLER FİŞLER PANOLAR**

► Kablolar, Fişler, Prizler, Elektrik Motorları  
Panolar

## ▶ MAKİNA EKİPMANLARI

▶ Çamurluklar, Plastik Dolaplar, Koltuklar  
Su Tankları

## ▶ BİSİKLETLİK PROFİLLER VE AYAKLARI

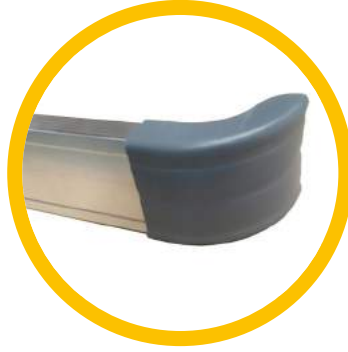
▶ Profiller, Plastik Köşeler, Bariyer  
Ayakları, Yangın Dolapları

## ▶ REFLEKTÖR ÜRÜNLER

▶ Reflektör Bantlar, Kamyon Ve Tır Arkası  
Reflektörler Tüm Reflektif Bant Çeşitleri



## ▶ MAKİNA LAMBALARI



▶ Tüm Araç Ve Ekipmanların Lamba ve Aksesuarları

## ▶ DİĞER MAKİNE EKİPMANARI

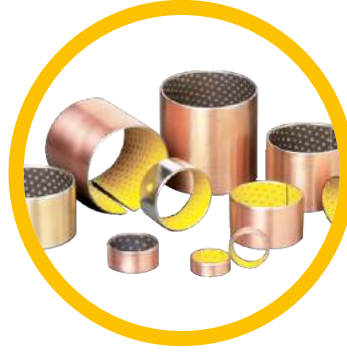

▶ Pup Burçlar, Fitiller, Amortisörler  
Lastik Takozlar



▶ Kilitler, Tutamaklar, Kapı Kolları, Plastik Pullar  
Menteşeler, Kabin Ekipmanları

**► CİVATA SOMUN SEKMAN**

► Civatalar, Somunlar Segmanlar  
Pullar Tüm Çeşitler

**► DELİCİ KESİCİLER - KAYNAK MALZEMELERİ**

► Matkap Uçları, Kılavuzlar, Kaynak  
Malzemeleri, Aşındırıcı Ürünler

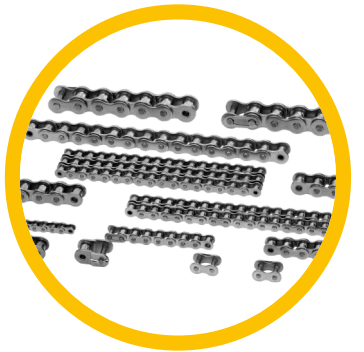
**► ZİNCİRLER**

► Flayer Zincirler, Makaralı Zincirler, Özel  
Zincirler

**► ÇEMBER DİŞLİLER****► Tek Sıra, Çift Sıra, motor Tahrikli  
Çember Dişliler****► SEPETLER****► Alüminyum Sepetler, Polyester Sepetler****► OPERATÖR KABİNLERİ****► Operatör Kabinleri**



 **ATILIM HİDROLİK**  
HİDROLİK PNOMATİK SAN. TİC. LTD. ŞTİ.



Sanayi Mah. İzmit Sanayi Sitesi 406 Blok 5.Cadde No:7/8 İzmit/KOCAELİ  
Telefon: +90 (262) 349 25 65 Faks: +90 (262) 349 25 65  
info@atilimhidrolik.com.tr www.atilimhidrolik.com.tr

